

Monocrystalline Module

JS182MHC132

510W

Maximum power output

0~+5W

Positive power tolerance

21.47%

Maximum Efficiency

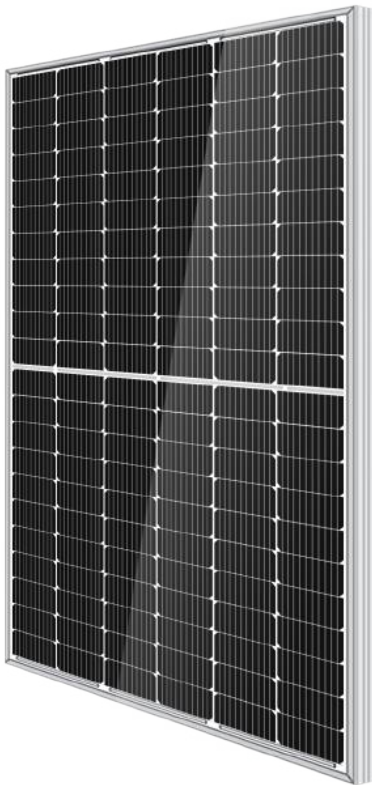

High power up to show

- Large area cells based on 182mm silicon wafers and half-cut cell technology
- Up to 21.47% module efficiency with high density interconnect technology
- Multi-busbar technology for better light trapping effect, lower series resistance and improved current collection



High customer value

- Lower guaranteed first year and annual degradation
- Designed for compatibility with existing mainstream system components
- Higher return on Investment



PID Resistant

- Minimized micro-cracks with innovative non-destructive cutting technology
- Ensured PID resistance through cell process and module material control

25

25- year power warranty

Comprehensive Products and System Certificates

ISO 9001
ISO 14001
ISO 45001
IEC 61215/IEC 61730
CGC

JS Solar' s performance Warranty

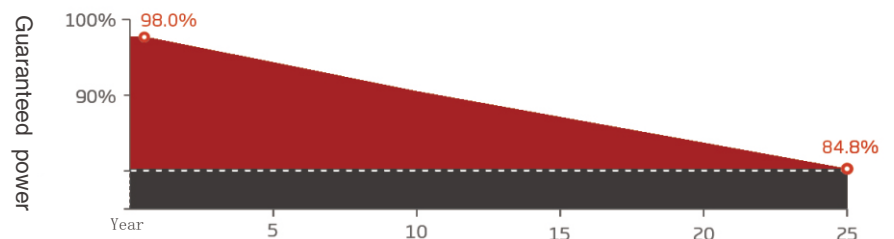

Module Size (mm)

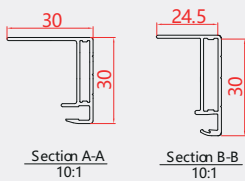
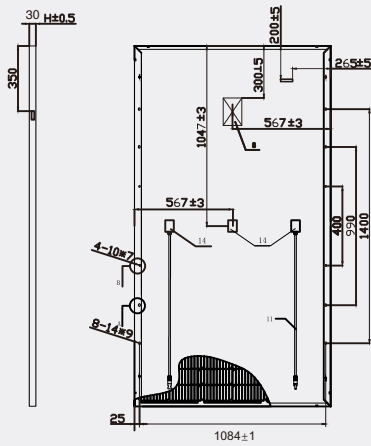
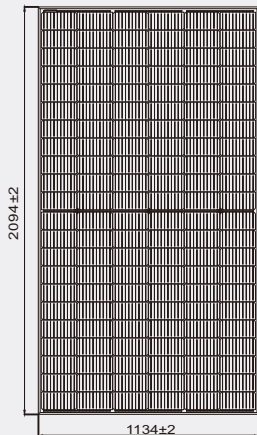

I-V Curve

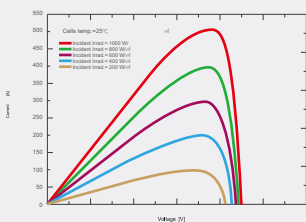
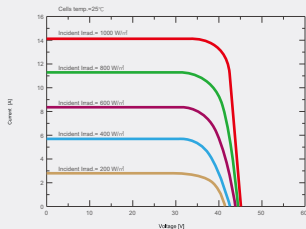

ELECTRICAL DATA (STC)

Peak Power Watts-PMAX (Wp)	485	490	495	500	505	510
Power Tolerance-PMAX (W)	0 ~ +5					
Maximum Power Voltage-VMPP (V)	37.1	30.73	37.5	37.7	37.9	38.1
Maximum Power Current-IMPP (A)	13.67	13.14	13.20	13.27	13.32	13.39
Open Circuit Voltage-VOC (V)	44.6	44.8	45.00	45.2	45.4	45.6
Short Circuit Current-ISC (A)	13.68	13.70	13.76	13.82	13.88	13.94
Module Efficiency η m (%)	20.42%	20.6%	20.8%	21.0%	21.3%	21.47%

STC: Irradiance 1000W/m² Cell Temperature 25°C Air Mass AM1.5.
*Measuring tolerance: ±3%.

ELECTRICAL DATA (NOCT)

Maximum Power-PMAX (Wp)	357	360	364	368	372	375
Maximum Power Voltage-VMPP (V)	34.6	34.8	35.0	35.2	38.4	35.6
Maximum Power Current-IMPP (A)	10.32	10.35	10.40	10.45	10.51	10.53
Open Circuit Voltage-VOC (V)	41.7	41.9	42.1	42.3	42.5	42.7
Short Circuit Current-ISC (A)	11.02	11.07	11.12	11.17	11.22	11.27

NOCT: Irradiance 800W/m², Ambient Temperature 20°C Wind Speed 1m/s

MECHANICAL DATA

Solar Cells	Monocrystalline
Cell Orientation	132 cells
Module Dimensions	2094x1134x30 mm
Weight	26 kg
Glass	3.2 mm, High Transmission, AR Coated Heat Strengthened Glass
Encapsulant Material	EVA
Backsheet	White
Frame	35 mm Anodized Aluminium Alloy
J-Box	IP 68 rated
Cables	Photovoltaic Technology Cable 4.0mm ² Portrait: N 300mm/P 300mm Length can be customized

*Please refer to regional datasheet for specified connector.

TEMPERATURE RATINGS

NOCT(Nominal Operating Cell Temperature)	43°C (±2°C)
Temperature Coefficient of PMAX	-0.34%/°C
Temperature Coefficient of VOC	-0.25%/°C
Temperature Coefficient of ISC	0.04%/°C

MAXIMUM RATINGS

Operational Temperature	-40 ~ +85°C
Maximum System Voltage	1500V DC (IEC)
Max Series Fuse Rating	20A

PACKAGING CONFIGURATION

Modules per box:	36 pieces
Modules per 40' container:	792 pieces